



**alples**

pohištvena znamka

# TREND

DNEVNE SOBE



TR-02

D: 4280+1660 V: 2084 G: 580/480/400





- 01\_G-302
- 02\_OV-161
- 03\_T-156
- 04\_PV-161
- 05\_O-201
- 06\_P-001
- 07\_K-207
- 08\_Z-208

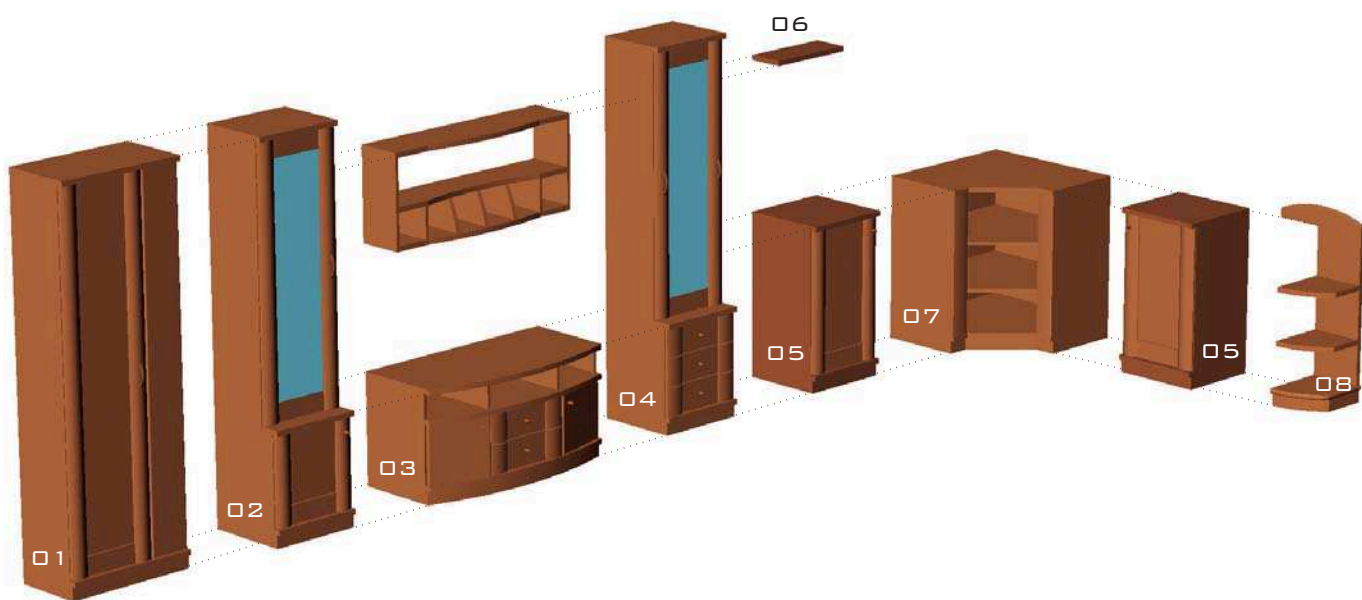



- 01 O-201
- 02 O-202
- 03 P-201
- 04 V-301
- 05 B-304





TR-03

D: 3200 V: 2084 G: 580/480/400









TR-01

D: 1860+3160 V: 2084 G: 480/400





TR-04

D: 2900 V: 2084 G: 800/480/400

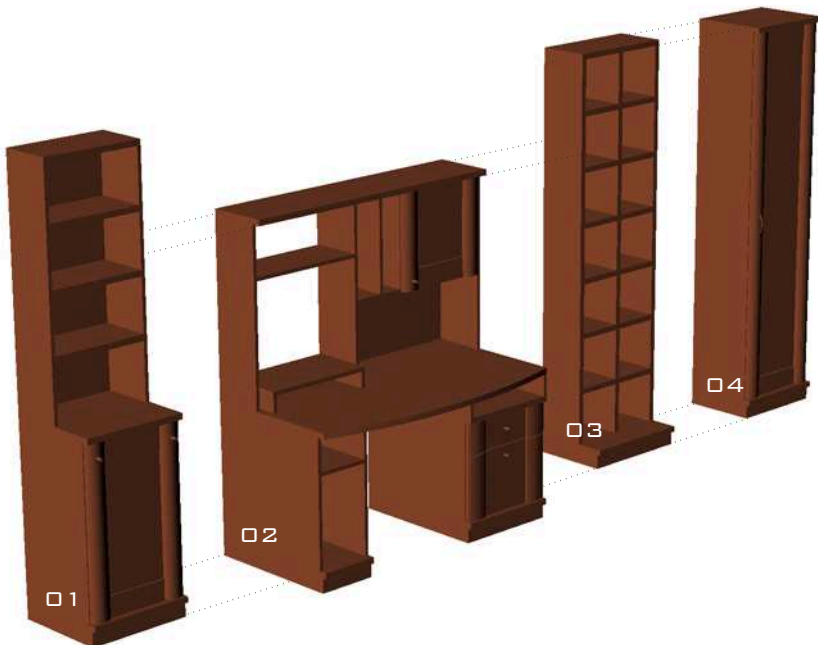

- 01 OB-271
- 02 RM-489
- 03 B-303
- 04 O-301

KLUBSKE MIZE TREND



KM TREND 100x74 ČE

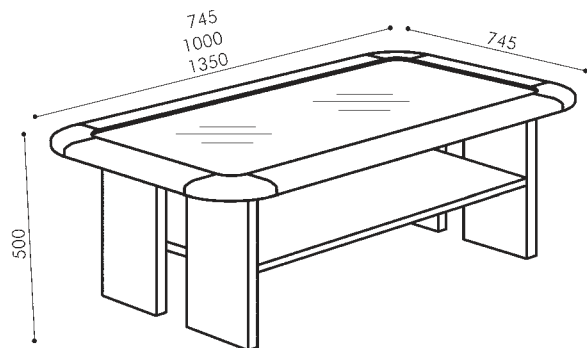

KM TREND 135x74 ČE



KM TREND 100x74 DR



KM TREND 74x74 ČE

UMIRJENE DNEVNE SOBE,  
SESTAVLJIVE,  
V TREH OSNOVNIH  
VIŠINAH, V PLEMENITI  
DREHOVI IN RADOŽIVI  
ČEŠNJEVI BARVI.

THESE SPACIOUS AND COMFORTABLE  
LIVING ROOMS COMBINE COMPLEMENTARY  
LIVING ENVIRONMENTS. THE WALNUT AND  
CHERRY TREE COLORED SURFACES  
EMBOLDEN AN ARRANGEMENT THAT STAGES  
THE ENSEMBLE IN DIFFERENT HEIGHTS.



## TR-01

P-101, O-101 x 2, K-107,  
PV-161, OB-161, V-301,  
Z-308, P-001, P-002



## TR-02

G-302, OV-161, T-156,  
PV-161, O-201 x 2,  
P-001, K-207, Z-208



## TR-03

V-301 x 2, T-306,  
OH-161, O-301



## TR-04

OB-271, RM-489,  
B-303, O-301



## TR-05

O-201 x 3, T-106, S-201,  
O-202, P-005 x 2, V-301,  
B-303, PB-161, O-301



## TR-06

O-201 x 3, O-202, P-201,  
V-301 x 2, B-304

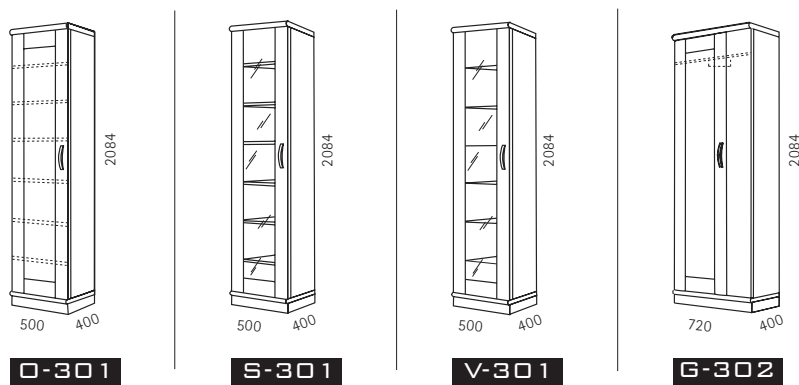
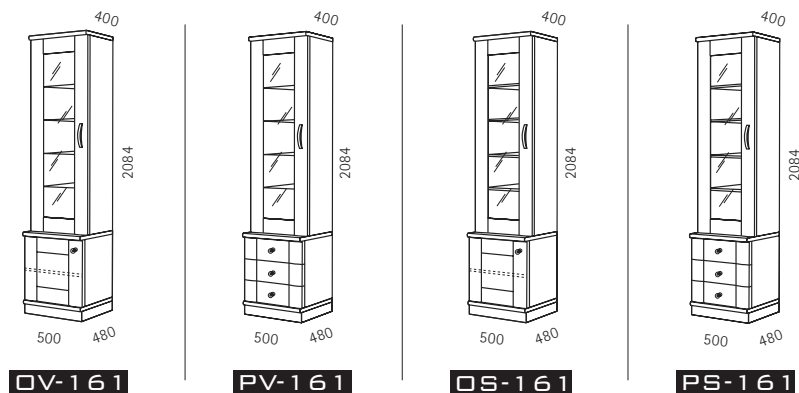
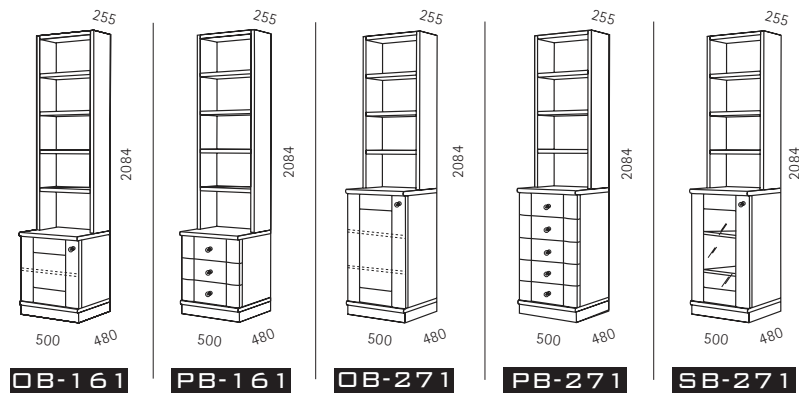
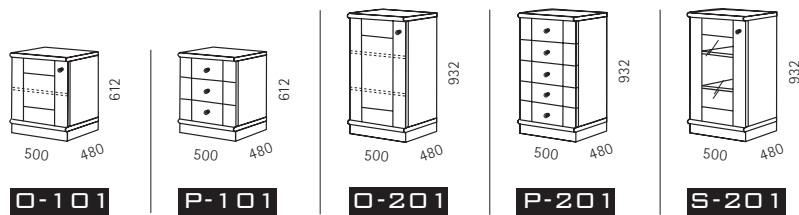

### LEGENDA / LEGEND

D: DOLŽINA / LENGTH    V: VIŠINA / HEIGHT

G: GLOBINA / DEPTH

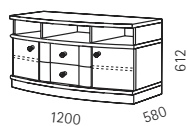

**T-106**

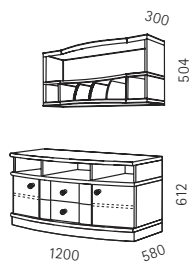

**T-156**

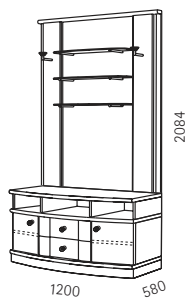

**T-306**

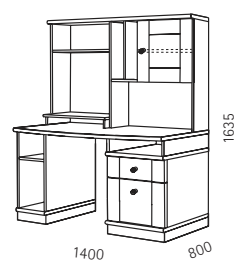

**RM-489**

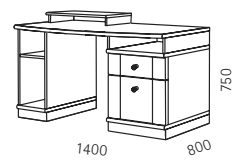

**RM-409**

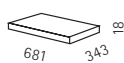

**H-001**

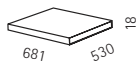

**H-002**

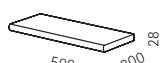

**P-001**

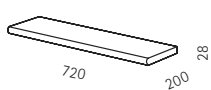

**P-002**

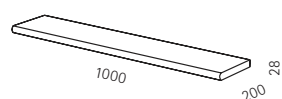

**P-005**

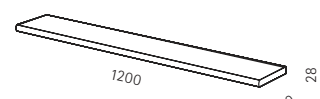

**P-006**

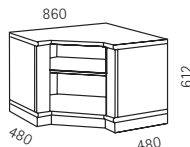

**K-107**



**K-207**



**Q-202**



**TRANSFOR.**

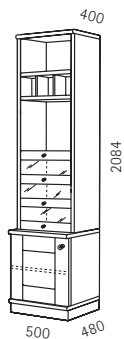

**OH-161**

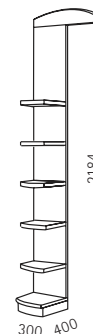

**Z-308**

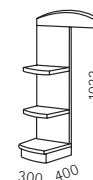

**Z-208**

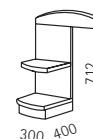

**Z-108**

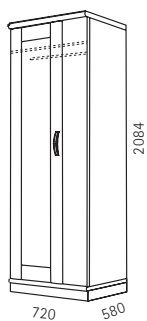

**G-302K**

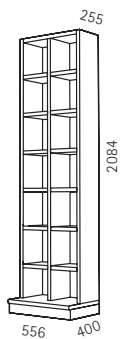

**B-303**

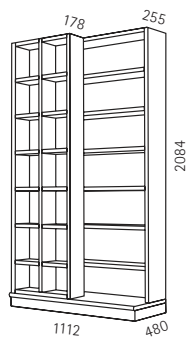

**B-304**



**ČEŠNJA / CHERRY**



**OREH / WALNUT**



...ko stanovanje postane dom.

ALPLES D.D.

4228 ŽELEZNIKI  
SLOVENIJA

TEL +386 (0)4 51 18 100  
FAX +386 (0)4 51 18 145

WWW.ALPLES.SI  
ALPLES@ALPLES.SI

ISO 9001  
BUREAU VERITAS  
Certification

